

Installation, Operation and Maintenance Manual

tekmarNet®4 Gateway 482

Introduction

The tekmarNet®4 Gateway 482 provides RS 232 serial communication between tekmarNet® Thermostats and third party automation systems. The third party automation system is able to monitor and adjust the thermostat's heating, cooling, and ventilation fan settings. Through the use of third party device drivers written for this product, tekmarNet® systems are fully integrated into home automation systems.

Features

- tekmarNet®4 and tekmarNet®2 Compatible
- CSA C US approved for US and Canada
- Drivers available for these third party automation systems*:
 AMX, Clare Controls, Control4, Crestron®, Elan, RTI, Savant, URC and Vantage home automation systems

*Trademarks are the property of their respective third party.

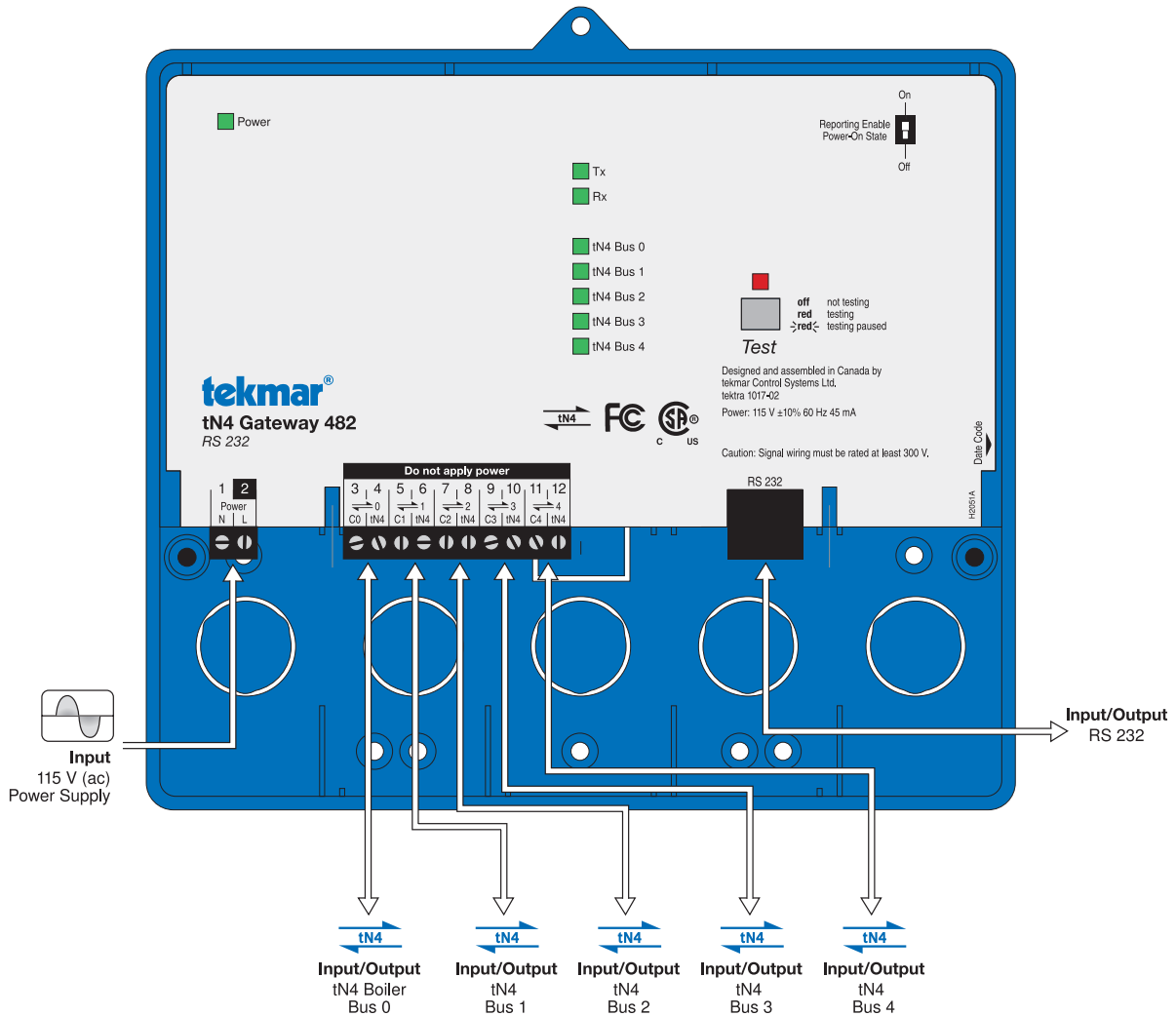

⚠ WARNING



Please read carefully before proceeding with installation. Your failure to follow any attached instructions or operating parameters may lead to the product's failure.

THINK SAFETY FIRST

Keep this Manual for future reference.

Table of Contents

Wiring	2	Sequence of Operation	10
Wiring Symbols	2	Before You Start.	10
Choosing a Location	2	Compatible Equipment	10
Mounting	3	Compatible Home Automation Systems.	10
Electrical Drawings	3-7	Reporting Enable DIP Switch.	10
Wiring the tN4 Gateway.	8	LED Status Indicators	10
Cleaning	8	tekmarNet® Home Automation Protocol.	10
Troubleshooting the Wiring.	9	Home Automation Commands.	11
Testing the Control.	9	Thermostat Addressing	11
		Technical Data	12
		Limited Warranty	12

Important Safety Information

⚠ WARNING



It is your responsibility to ensure that this control is safely installed according to all applicable codes and standards. tekmar is not responsible for damages resulting from improper installation and/or maintenance.

To avoid serious personal injury and damage to the equipment:



- Read Manual and all product labels BEFORE using the equipment. Do not use unless you know the safe and proper operation of this equipment.



- Keep this Manual available for easy access by all users.
- Replacement Manuals are available at tekmarControls.com
- Disconnect all power before opening the control.
- It is the installers responsibility to ensure that this control is safely installed according to all applicable codes and standards.

- Improper installation and operation of this control could result in damage to the equipment and possibly even personal injury or death.
- This electronic control is not intended for use as a primary limit control. Other controls that are intended and certified as safety limits must be placed into the control circuit.
- Do not attempt to service the control. Apart from any field replaceable fuse(s) there are no user serviceable parts. Attempting to do so voids warranty.

Wiring

Wiring Symbols

Do Not Apply Power

Do not apply power to these terminals. Serious control damage will result.



Earth ground

Choosing a Location

The location of the tN4 Gateway is important. To ensure proper wiring during rough in, select an appropriate location for the control early in the construction process. Consider the following:

- Do not expose the tN4 Gateway to temperatures beyond 32 to 122°F (0 to 50°C).
- Keep dry. Avoid potential leakage onto the control.
- Relative humidity ≤ 92% to 104°F (40°C), down to 50% above 104°F (40°C).
- Provide adequate ventilation.
- Keep away from equipment, appliances or other sources of electrical interference.
- Mount the enclosure to a solid backing.
- Provide easy access for wiring and viewing.
- Mount approximately 5 feet (1.5 m) off the finished floor.
- Mount near the zone managers, reset modules, tN4 thermostats, tN4 setpoint controls, and mixing expansion modules. The total wire length of each tN4 bus cannot exceed 5000 feet.
- Each tN4 bus consists of a pair of wires (tN4 and C).
- The tN4 Gateway can accept up to 5 tN4 buses.
- Use a Category 5 cable up to or less than 150 feet (45 m) in length to connect the tN4 Gateway to the home automation equipment.

Mounting

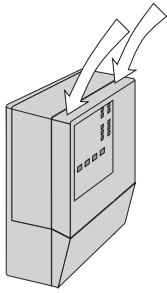

Press down at the fingertip grips on top of the front cover and pull out and down.

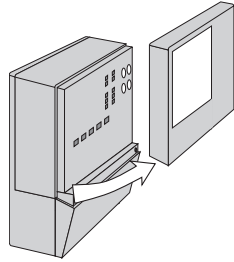

Lift the front cover up and away from the control.

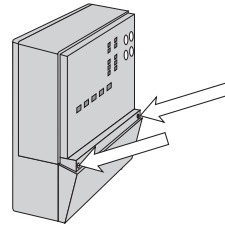

Loosen the screws at the front of the wiring cover.

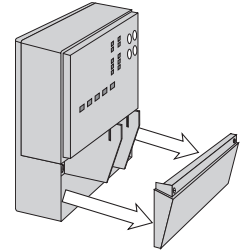

The wiring cover pulls straight out from the wiring chamber.

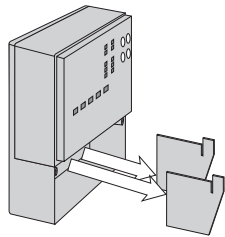

Remove the safety dividers from the wiring chamber by pulling them straight out of their grooves.

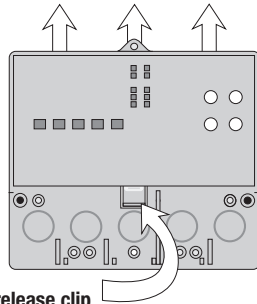

Control release clip

Press the control release clip on the base inside the wiring chamber and slide the control upwards.

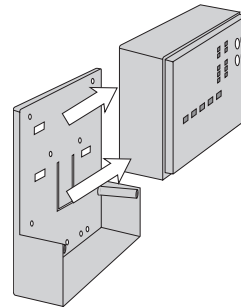

The control lifts up and away from the base.

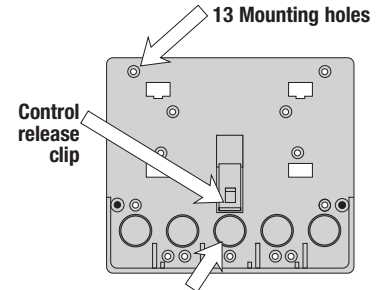

13 Mounting holes

Control release clip

There are 10 conduit knock-outs at the back and bottom of the wiring chamber.

The base is ready for mounting.

The control can be mounted on a standard DIN rail. First remove the control from its base and then, using the hooks and spring clip on the back of the control, mount it onto the DIN rail. This will be a popular option for those who prefer to mount the control inside a larger electrical panel.

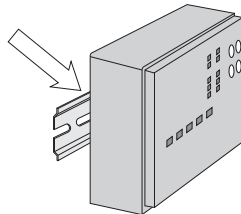

The wiring can enter the bottom or the back of the enclosure. Knock-outs provided in the base allow the wiring to be run in conduit up to the enclosure. The base also has holes that line up with the mounting holes of most common electrical boxes.

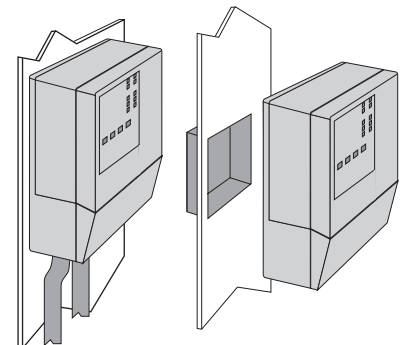

Included Parts

- One tN4 Gateway 482
- One RJ45 to DB9 Adapter
- One Installation and Operation Manual IOM-T-482
- One Job Record 482_J
- One Plastic Bag for Brochures
- One Screwdriver

Electrical Drawings

⚠ The electrical drawing examples on the following pages show the 482 in common applications. These drawings have a brief explanation of what is being operated in each system. Choose the components in your system and use the drawings as a guide to aid in wiring your system. These are only concept drawings, not engineered drawings. They are not intended to describe a complete system nor any particular system. It is up to the system

designer to determine the necessary components for and configuration of the particular system being designed including additional equipment, isolation relays (for loads greater than the controls specified output ratings) and any safety devices, which in the judgment of the designer are appropriate in order to properly size, configure and design that system and to ensure compliance with building and safety code requirements.

Description: tN4 network of tekmarNet® thermostats are connected to a tN4 Gateway 482.

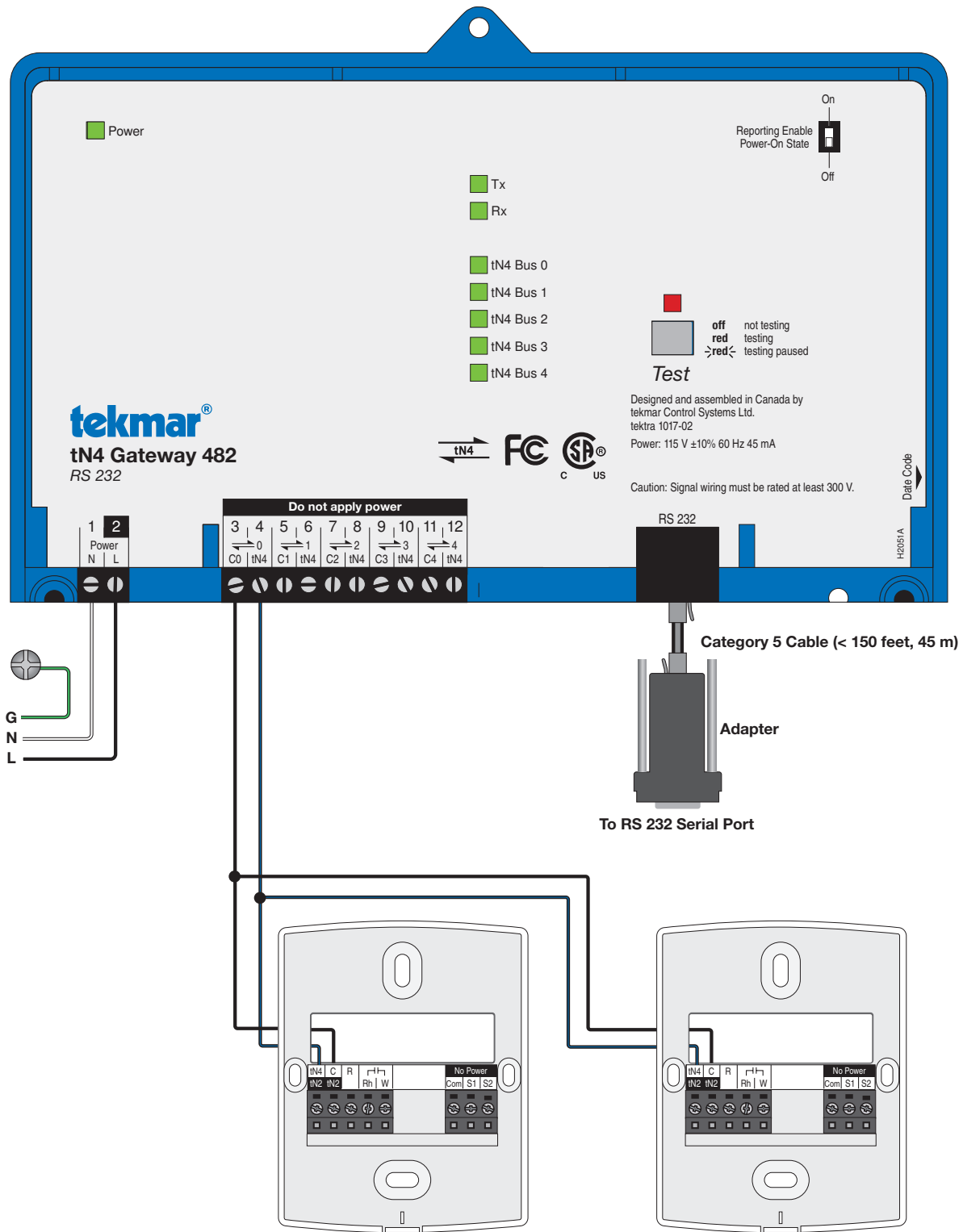

Refer to Thermostat wiring brochures for complete wiring schematic.

There is a limit of 24 devices per tN4 bus. Additional thermostats can be wired to the next available bus up to a maximum of 96 devices per system.

Description: A Universal Reset Module 422 and Dual Zone Manager 337 are connected to a tN4 Gateway 482.

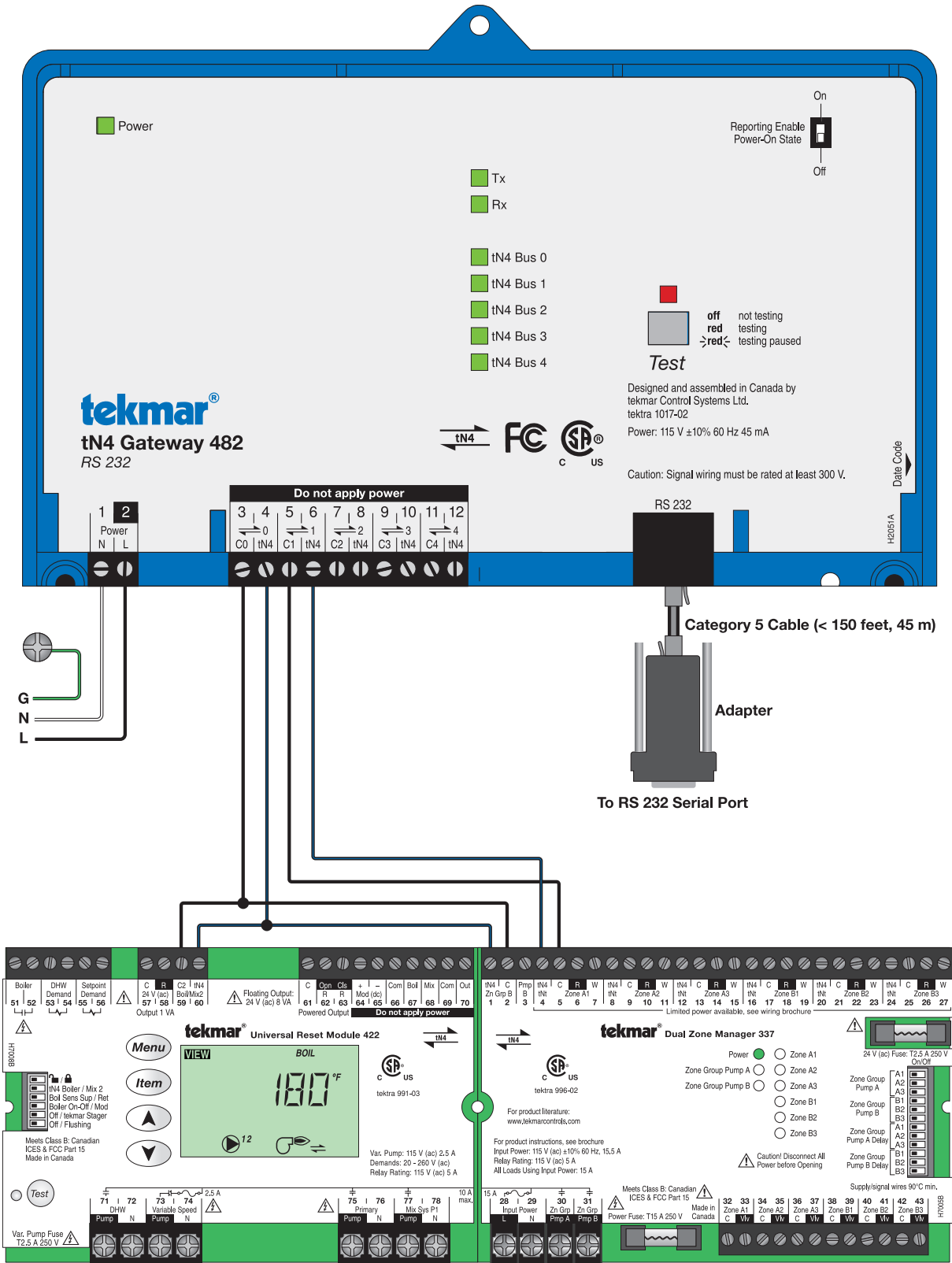

Refer to W422 and W337 wiring brochures for complete wiring schematic.

Description: A Universal Reset Module 423 and Power Manager 345 are connected to a tN4 Gateway 482.

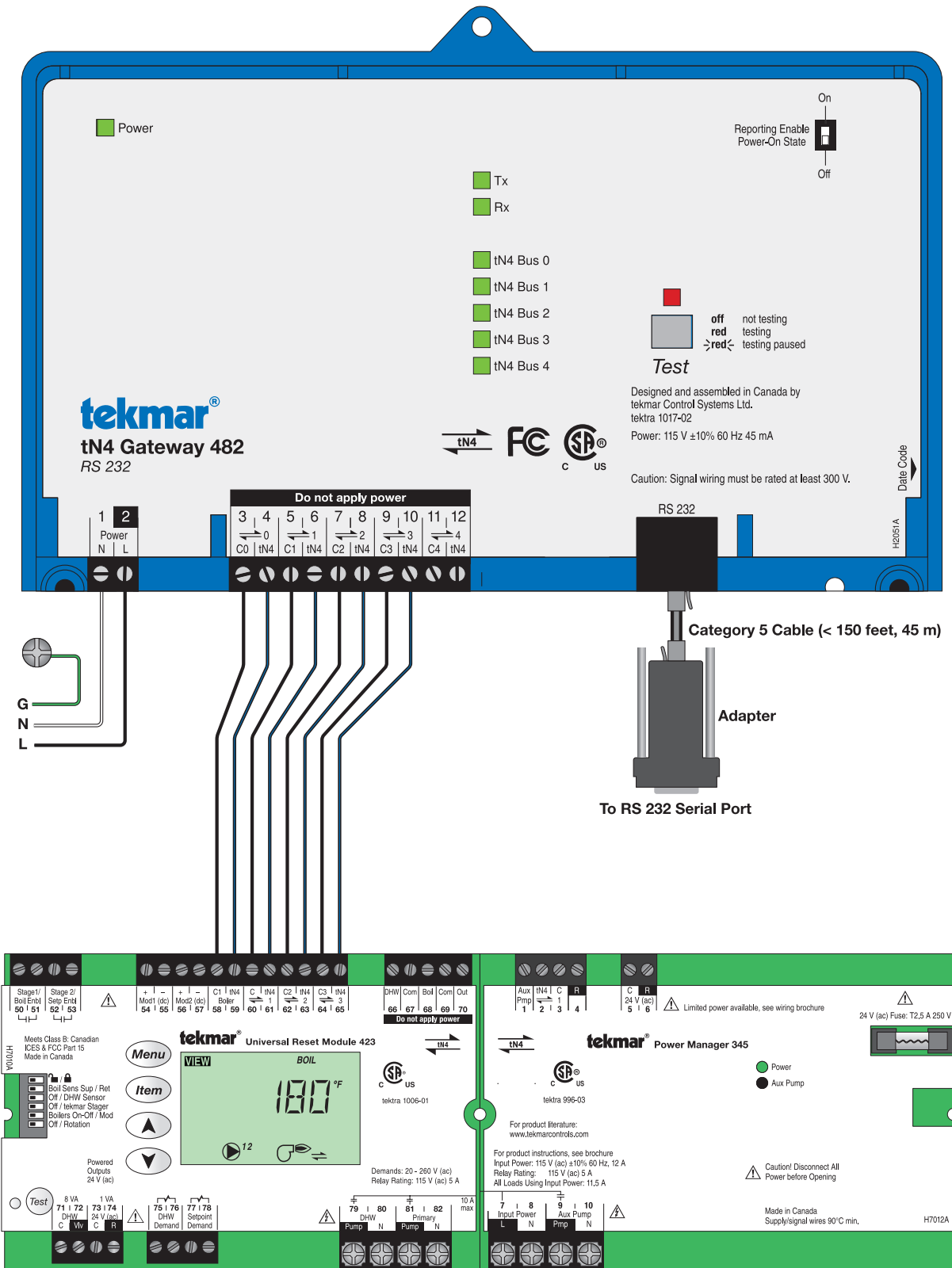

Refer to W423 and W345 wiring brochures for complete wiring schematics.

Description: A tN2 House Control 402 is connected to a tN4 Gateway 482.

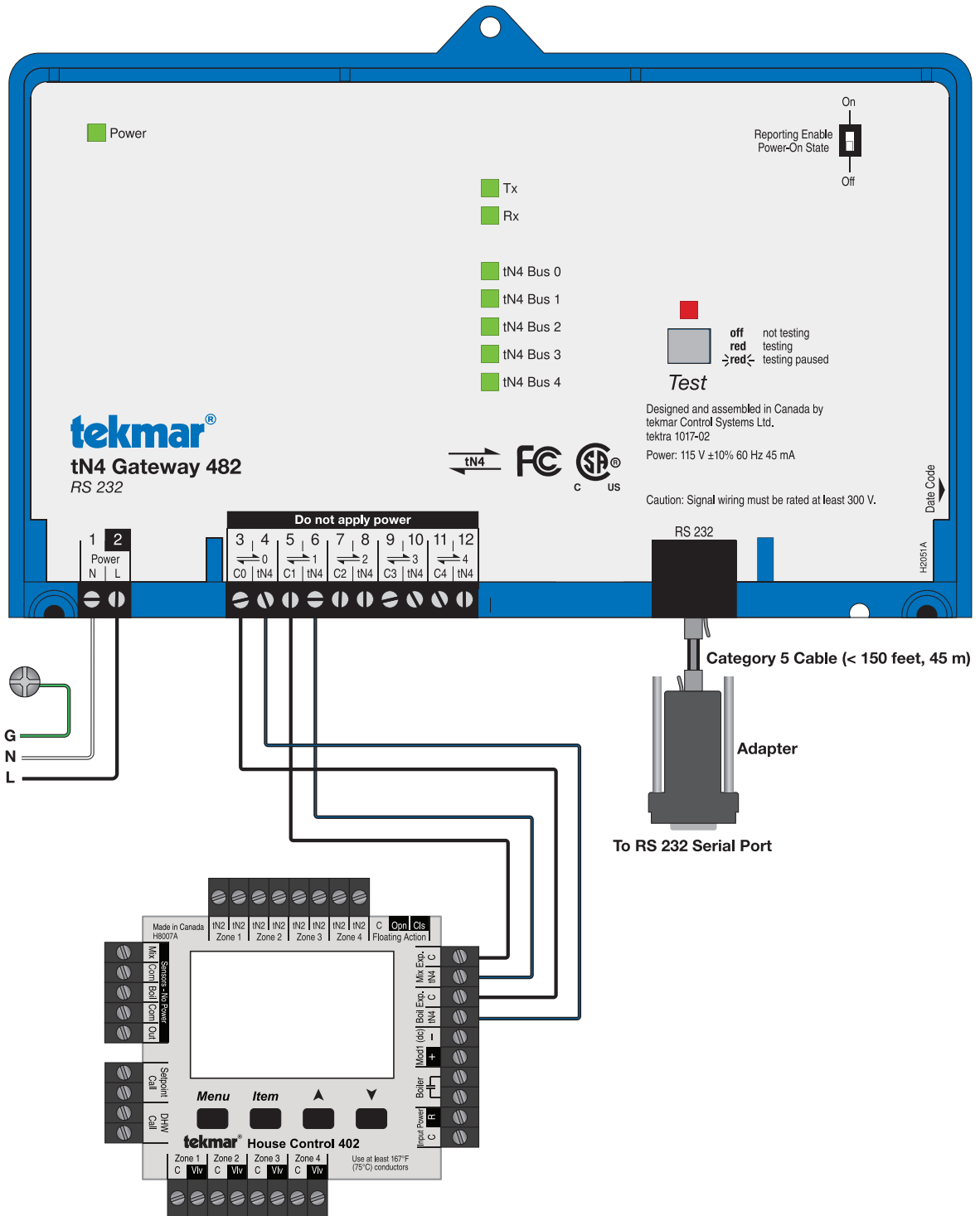

Refer to the 402 Installation & Operation Manual for a complete wiring schematic.

Wiring the tN4 Gateway

Terminals 1-12

This section explains how to wire individual devices to the tN4 Gateway. For step-by-step wiring, refer to the terminal number on the right of the page.

- Before wiring ensure all power is turned off and take all necessary precautions.
- Install the supplied wiring compartment barriers by sliding them into the grooves provided to isolate the low and high voltage wiring.
- Refer to the current and voltage ratings at the back of this brochure before connecting devices to this control.

- All wires must be rated at least 300 V.
- High voltage wires should be 14 AWG conductors.
- Low voltage wires should be 18 AWG conductors.
- Strip all wiring to a length of $\frac{3}{8}$ in. or 10 mm for all terminals.
- Only qualified personnel should attempt installation of the tN4 Gateway.

⚠ Power Requirements

- Provide a 15 A circuit for the power.
- An approved circuit breaker or power disconnect that de-energizes the high voltage wiring should be located near the tN4 Gateway, and marked as the 115 V (ac) power disconnect for this device.
- 115 V (ac) high voltage power supply circuits must be protected by 15 A maximum overcurrent protection.
- Connect 115 V (ac) hot (L) to terminal 2.
- Connect 115 V (ac) neutral (N) to terminal 1.
- Connect the ground wire to one of the ground screws provided in the wiring chamber.

Terminals 1-2

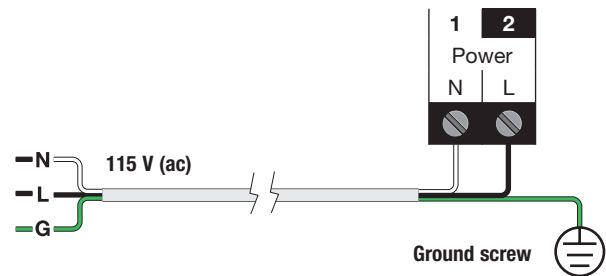

tN4 Bus Inputs

Terminals 3 - 12

The tN4 Gateway includes five tN4 buses:

- tN4 Bus 0 (terminals 3 and 4)
- tN4 Bus 1 (terminals 5 and 6)
- tN4 Bus 2 (terminals 7 and 8)
- tN4 Bus 3 (terminals 9 and 10)
- tN4 Bus 4 (terminals 11 and 12)

Each tN4 bus consists of a tN4 terminal as well as a C terminal.

Polarity is important.

Connect each tN4 bus on the system to a tN4 bus input on the 482. The tN4 bus order on the 482 is not critical;

however, it is recommended to connect them to the 482 in the same order in order to avoid confusion during troubleshooting.

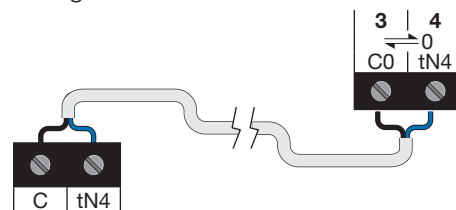

RS 232 Serial Port

Use a Category 5 cable with an RJ45 connector and plug it into the 482 RS 232 serial port. Connect the opposing end RJ45 connector into the RJ45 to DB9 adapter.

The adapter uses the following pin connections:

- Pin 3 - Data Terminal Ready (firmware programming only)
- Pin 4 - Signal Ground
- Pin 5 - Receive Data
- Pin 6 - Transmit Data

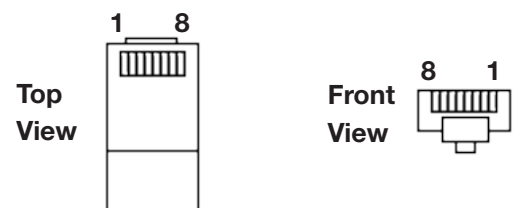

Cleaning

The 482 exterior can be cleaned using a damp cloth. Moisten the cloth with water and wring out prior to wiping the device. Do not use solvents or cleaning solutions.

Troubleshooting the Wiring

⚠ General

The following tests are to be performed using standard testing practices and procedures and should only be carried out by properly trained and experienced persons.

A good quality electrical test meter, capable of reading from at least 0-300 V (ac), 0-30 V (dc), 0-2,000,000 Ohms, and testing for continuity is essential to properly test the wiring and sensors.

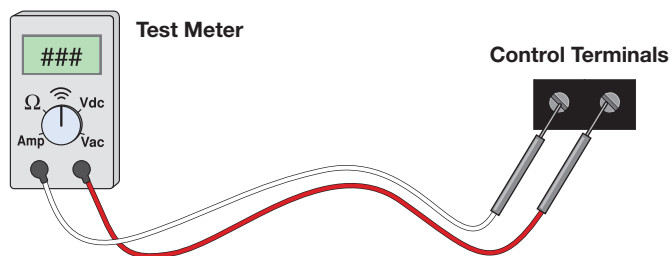

Testing the Control

Testing the Power

1. Remove the front and wiring covers from the control.
2. Use an electrical test meter to measure (ac) voltage between the Power N and L terminals (1 and 2). The reading should be 115 V (ac) + / - 10%. The Power LED should be on.
3. If power is not present the Power LED will be off. Check the circuit(s) that supply power to the Power N and L terminals (1 and 2).

Testing the tN4 Buses

1. Remove the front and wiring covers from the control.
2. There are a total of five tN4 buses (tN4 and C). The corresponding tN4 LED will be on if there is communication on the tN4 bus.
3. If there is no communication on a tN4 bus that is supposed to have communication, there may be an open or short circuit. An open or short circuit will be indicated as a bus error on any tN4 thermostats, tN4 setpoint controls, and tN4 system controls.
4. To test for short circuits:
 - Disconnect the tN4 bus wires on both ends.
 - Install wire nuts on each wire on one end to ensure the wire ends are not touching.
 - Measure for continuity using an electrical meter.
 - If continuity is present, there is a short circuit fault along the wires. It is recommended to replace the tN4 bus wires.
5. To test for open circuits:
 - Disconnect the tN4 bus wires on one end and connect them together.
 - Disconnect the tN4 bus wires on the other end.
 - Use an electrical meter to measure for continuity.
 - If there is no continuity, there is an open circuit fault along the wires. It is recommended to replace the tN4 bus wires.

Testing the RS 232 Serial Port

A terminal shell called Termite can be used to test the RS 232 serial port hexadecimal data.

Step 1: Download the Termite (complete setup) terminal program for Windows.

http://www.compuphase.com/software_termite.htm

Step 2: Settings

Baud rate = 9600, Data bits = 8, Stop bits = 1, Parity = none, Flow control = none, Forward = none
Hex View = check marked

Step 3: Enter commands

Hexadecimal values can be entered in the command line at the bottom. The hexadecimal numbers must be entered in the format 0x00 followed by a space.

The 482 includes a built-in test routine that transmits a message via the RS232 port. The result of this is that the Tx indicator will flash as the message is sent.

Start the test routine by pressing the Test button for 1 second. The Test LED turns red.



The RS232 message includes the following:

1. FirmwareRevision

0xca 0x07 0x06 0x02 0x87 0x01 0x00 0x00 **0x91** 0x00 0x28 0x35

This means that the 482 firmware version is 6c hexadecimal or 145 in decimal.

2. ProtocolVersion

0xca 0x07 0x06 0x02 0x8f 0x01 0x00 0x00 **0x02** 0x00 0xa1 0x35

This means that the 482 protocol version is 02.

The 482 then exits the test routine and resumes normal operation.

Sequence of Operation

Before You Start

Before connecting the tN4 Gateway to a tekmarNet® system, it is recommended that the system be fully completed, with no tekmarNet® thermostats being added or removed at a later date. Also, each tekmarNet® thermostat is automatically assigned a tekmarNet® address when con-

nected to the system. When using a Gateway, each device requires a manual address. This address should be written down together with the room location for future reference using the Job Record J 482 and will be required in order to name the room on the home automation equipment.

Compatible Equipment

The tN4 Gateway 482 can communicate and control the following tekmar products:

- tekmarNet® Setpoint Control 161, 162
- tekmarNet® Thermostat 532, 552, 553, 554, 557
- Snow Melting Control 654, 670, 671

The 482 is compatible with the following boiler controls but does not communicate with them:

- Boiler Control 274, 274, 284
- House Control 400, 401, 402, 403, 406
- Reset Module 420, 421, 422, 423

The 482 is compatible with the following discontinued products:

- tekmarNet®2 Thermostat 527, 528, 529, 530
- tekmarNet®4 Thermostat 537, 538, 540, 541, 542, 543*, 544, 545, 546

*543 software versions J1126A to J1126I are not fully compatible with the 482. Please contact your tekmar sales representative for assistance with affected 543 products.

The tN4 Gateway 482 is not compatible with the tN4 Gateway 485 or 486. Two tN4 Gateway products cannot be installed on the same heating system.

Compatible Home Automation Systems

The following home automation systems* have software drivers for the 482:

AMX	Control4	Savant
Clare Controls	Elan	URC
Crestron	RTI	Vantage

The software drivers are available through the home automation company.

Refer to the 482 product page on tekmar's website <http://tekmarcontrols.com/accessories/482.html> for an up to date list of compatible home automation systems.

*Trademarks are the property of their respective automation company.

Reporting Enable DIP Switch

The 482 supports an option to automatically report thermostat information once every minute. The Reporting Enable Power On State DIP switch selects if Reporting Enable is normally

on or normally off when powered on. Most home automation systems require the reporting enable to be set to on. Older home automation equipment may require this to be set to off.

LED Status Indicators

LEDS	ON	OFF
■ Power	Power is on.	Power is off.
■ Tx	Flashes when RS232 message is sent.	No RS232 message.
■ Rx	Flashes when RS232 message is received.	No RS232 message.
■ tN4 Bus 0	tN4 communication on bus 0 (b) is present.	No tN4 communication on bus 0.
■ tN4 Bus 1	tN4 communication on bus 1 is present.	No tN4 communication on bus 1.
■ tN4 Bus 2	tN4 communication on bus 2 is present.	No tN4 communication on bus 2.
■ tN4 Bus 3	tN4 communication on bus 3 is present.	No tN4 communication on bus 3.
■ tN4 Bus 4	tN4 communication on bus 4 is present.	No tN4 communication on bus 4.

tekmarNet® Home Automation Protocol

The tekmarNet® Home Automation protocol documentation is available on the tekmar website at:

<https://www.watts.com/our-story/brands/tekmar/ta>

Home Automation Commands

COMMAND	THERMOSTAT (HEAT ONLY)		THERMOSTAT (HEAT-COOL)			SETPOINT CONTROLS		SNOW MELT		
	532	552	553	554	557	161	162	654	670	671
Room temperature	•	•	•	•	•	•	•			
Floor temperature***	•	•	•	•	•					
Mode	•	•	•	•	•					
Heat setpoint	•	•	•	•	•					
Cool setpoint			•	•	•					
Slab setpoint*	•	•	•	•	•					
Setpoint control setpoint						•	•			
Fan			•	•	•					
Relative humidity%			•		•					
Maximum humidity setpoint			•		•					
Minimum humidity setpoint			•		•					
Outdoor temperature**	•	•	•	•	•			•	•	•
Melt/storm/setpoint enable						•	•	•	•	•

* Not supported by some home automation drivers

** Requires an outdoor sensor to be connected to a thermostat, snow melt or boiler control

*** Floor temperature available when a floor sensor is installed to an auxiliary sensor input

Thermostat Addressing

Each thermostat and setpoint control uses the following format for addressing: **Port:Bus:Thermostat Device**. The snow melting control does not reports its address to the 482. The Bus and Thermostat Device are visible on the thermostat and setpoint control's LCD display. This is documented as the 'tekmarNet Address' in the thermostat data brochure.

Port Number

The leading digit is the Port number. This determined by the wiring connection that the thermostat is wired to on the 482.

482 tN4 Bus 0 or b = 0 482 tN4 Bus 3 = 3
 482 tN4 Bus 1 = 1 482 tN4 Bus 4 = 4
 482 tN4 Bus 2 = 2

Bus Number

The second digit is the thermostat bus number. The bus number is pre-determined by the wiring of the thermostat to a boiler or mixing reset control water temperature bus. In the event that no reset control is installed, the bus number is 0.

CONTROL	BUS	BUS #	CONTROL	BUS	BUS #
274	Boiler	1	403	Boiler	2
275	Boiler	1	420	Boiler	1
284	b	1	421	Mix	1
284	1	2	422	Mix1	1
284	2	3	422	Boiler	2
284	3	4	422	Mix2	2
400	Boiler	1	423	Bus1	1
401	Boiler	1	423	Bus2	2
402	Mix	1	423	Bus3	3
402	Boiler	2	423	Boiler	4
403	Mix	1			

The 406 tN4 bus numbering is dependent on the WaterTemp and the Zone settings when configuring the control.

WATERTEMP	ZONES	TANK BUS	MIX BUS	BOILER BUS
T	—	1		—
T + M	—	1	2	—
T + B	—	1	—	2
T + MB	Mix	1	*	3
T + MB	Boil	1	2	*

*When the 406 is configured in this manner, thermostats on this bus are unable to communicate to the Gateway 482.

Thermostat Device Number

The third and fourth digits indicate the thermostat device number. The thermostat device number is a two digit number that ranges from 01 to 24 and can be determined from the thermostat address. To determine the thermostat address, please consult the data brochure for the appropriate thermostat.

Example 1

A thermostat with bus and thermostat device number of b:01 is wired to a model 400 controller boiler bus and in turn is wired to the 482 on port 0. This address is 0101.

Example 2

A thermostat with bus and thermostat device number of b:24 is wired to a model 423 controller boiler bus and in turn is wired to the 482 on port 0. This address is 0424.

Example 3

A group of thermostats are wired together to create a stand-alone network. A thermostat with thermostat device number 15 is wired to the 482 on port 0. This address is 0015.

Technical Data

tN4 Gateway 482; RS 232

Literature	Submittal, Installation and Operating Manual, Job Record
Control	Microprocessor PID control; This is not a safety (limit) control
Packaged weight	3.6 lb. (1600 g)
Dimensions	6 ⁵ / ₈ " H x 7 ⁹ / ₁₆ " W x 2 ¹³ / ₁₆ " D (170 x 193 x 72 mm)
Enclosure	Enclosure A, blue PVC plastic, NEMA type 1
Approvals	CSA C US, meets ICES & FCC regulations for EMI / RFI
Ambient conditions	Indoor use only, 32 to 122°F (0 to 50°C), RH ≤ 92% to 104°F (40°C), down to 50% above 104°F (40°C), 9842 feet (3000 m) maximum altitude
Power Supply	115 V ± 10%, 60 Hz, 45 mA

This device complies with Part 15 of the FCC rules. Operation is subject to the following two conditions: (1) This device may not cause harmful interference, and (2) this device must accept any interference received, including interference that may cause undesired operation.

The installer must ensure that this control and its wiring are isolated and / or shielded from strong sources of electromagnetic noise. Conversely, this Class B digital apparatus complies with Part 15 of the FCC Rules and meets all requirements of the Canadian Interference-Causing Equipment Regulations. However, if this control does cause harmful interference to radio or television reception, which is determined by turning the control off and on, the user is encouraged to try to correct the interference by re-orientating or relocating the receiving antenna, relocating the receiver with respect to this control, and / or connecting the control to a different circuit from that to which the receiver is connected.

Cet appareil numérique de la classe B respecte toutes les exigences du Règlement sur le matériel brouilleur du Canada.

Limited Warranty and Product Return Procedure

Limited Warranty *The liability of tekmar under this warranty is limited. The Purchaser, by taking receipt of any tekmar product ("Product"), acknowledges the terms of the Limited Warranty in effect at the time of such Product sale and acknowledges that it has read and understands same.*

The tekmar Limited Warranty to the Purchaser on the Products sold hereunder is a manufacturer's pass-through warranty which the Purchaser is authorized to pass through to its customers. Under the Limited Warranty, each tekmar Product is warranted against defects in workmanship and materials if the Product is installed and used in compliance with tekmar's instructions, ordinary wear and tear excepted. The pass-through warranty period is for a period of twenty-four (24) months from the production date if the Product is not installed during that period, or twelve (12) months from the documented date of installation if installed within twenty-four (24) months from the production date.

The liability of tekmar under the Limited Warranty shall be limited to, at tekmar's sole discretion: the cost of parts and labor provided by tekmar to repair defects in materials and / or workmanship of the defective product; or to the exchange of the defective product for a warranty replacement product; or to the granting of credit limited to the original cost of the defective product, and such repair, exchange or credit shall be the sole remedy available from tekmar, and, without limiting the foregoing in any way, tekmar is not responsible, in contract, tort or strict product liability, for any other losses, costs, expenses, inconveniences, or damages, whether direct, indirect, special, secondary, incidental or consequential, arising from ownership or use of the product, or from defects in workmanship or materials, including any liability for fundamental breach of contract.

The pass-through Limited Warranty applies only to those defective Products returned to tekmar during the warranty period. This Limited Warranty does not cover the cost of the parts or labor to remove or transport the defective Product, or to reinstall the repaired or replacement Product, all such costs and expenses being subject to Purchaser's agreement and warranty with its customers.

Any representations or warranties about the Products made by Purchaser to its customers which are different from or in excess of the tekmar Limited Warranty are the Purchaser's sole responsibility and obligation. Purchaser shall indemnify and hold tekmar harmless from and against any and all claims, liabilities and damages of any kind or nature which arise out of or are related to any such representations or warranties by Purchaser to its customers.

The pass-through Limited Warranty does not apply if the returned Product has been damaged by negligence by persons other than tekmar, accident, fire, Act of God, abuse or misuse; or has been damaged by modifications, alterations or attachments made subsequent to purchase which have not been authorized by tekmar; or if the Product was not installed in compliance with tekmar's instructions and / or the local codes and ordinances; or if due to defective installation of the Product; or if the Product was not used in compliance with tekmar's instructions.

THIS WARRANTY IS IN LIEU OF ALL OTHER WARRANTIES, EXPRESS OR IMPLIED, WHICH THE GOVERNING LAW ALLOWS PARTIES TO CONTRACTUALLY EXCLUDE, INCLUDING, WITHOUT LIMITATION, IMPLIED WARRANTIES OF MERCHANTABILITY AND FITNESS FOR A PARTICULAR PURPOSE, DURABILITY OR DESCRIPTION OF THE PRODUCT, ITS NON-INFRINGEMENT OF ANY RELEVANT PATENTS OR TRADEMARKS, AND ITS COMPLIANCE WITH OR NON-VIOLATION OF ANY APPLICABLE ENVIRONMENTAL, HEALTH OR SAFETY LEGISLATION; THE TERM OF ANY OTHER WARRANTY NOT HEREBY CONTRACTUALLY EXCLUDED IS LIMITED SUCH THAT IT SHALL NOT EXTEND BEYOND TWENTY-FOUR (24) MONTHS FROM THE PRODUCTION DATE, TO THE EXTENT THAT SUCH LIMITATION IS ALLOWED BY THE GOVERNING LAW.

Product Warranty Return Procedure All Products that are believed to have defects in workmanship or materials must be returned, together with a written description of the defect, to the tekmar Representative assigned to the territory in which such Product is located. If tekmar receives an inquiry from someone other than a tekmar Representative, including an inquiry from Purchaser (if not a tekmar Representative) or Purchaser's customers, regarding a potential warranty claim, tekmar's sole obligation shall be to provide the address and other contact information regarding the appropriate Representative.

tekmar[®]

A WATTS Brand