

THESE DRAWINGS AND/OR SPECIFICATIONS ARE THE PROPERTY OF AERCO INTERNATIONAL, INC. THEY ARE ISSUED IN STRICT CONFIDENCE AND SHALL NOT BE REPRODUCED, COPIED, OR USED AS THE BASIS FOR MANUFACTURE OR SALE OF APPARATUS WITHOUT PERMISSION OF THE OWNER.

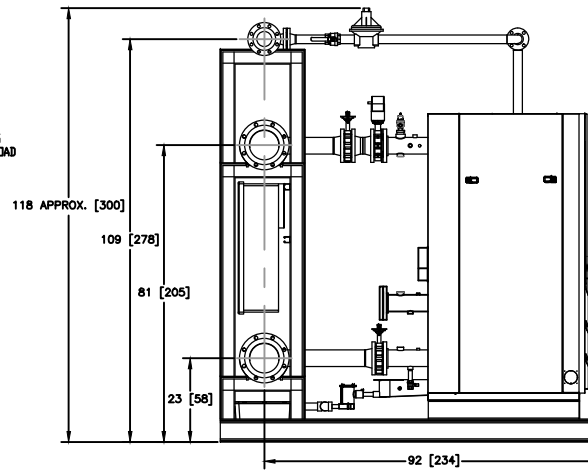
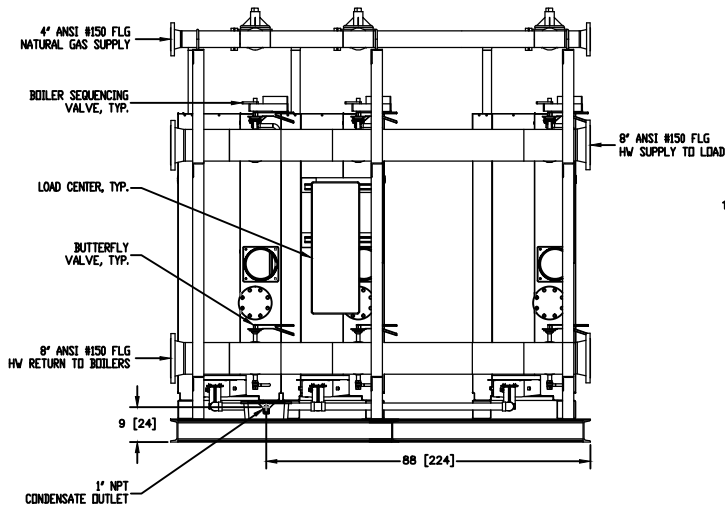
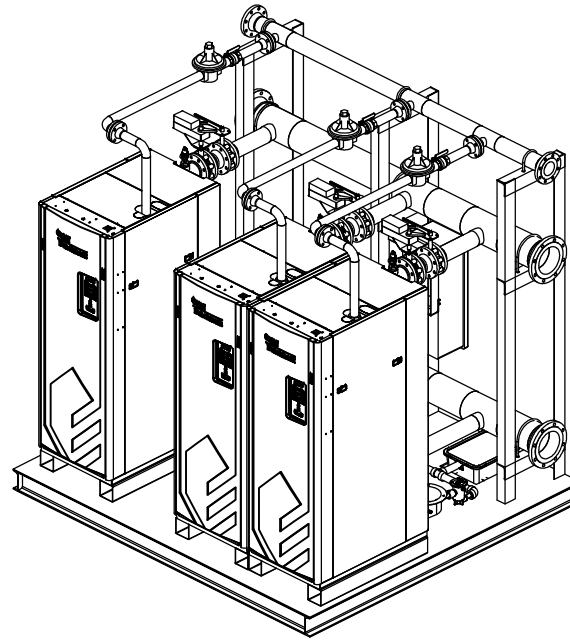
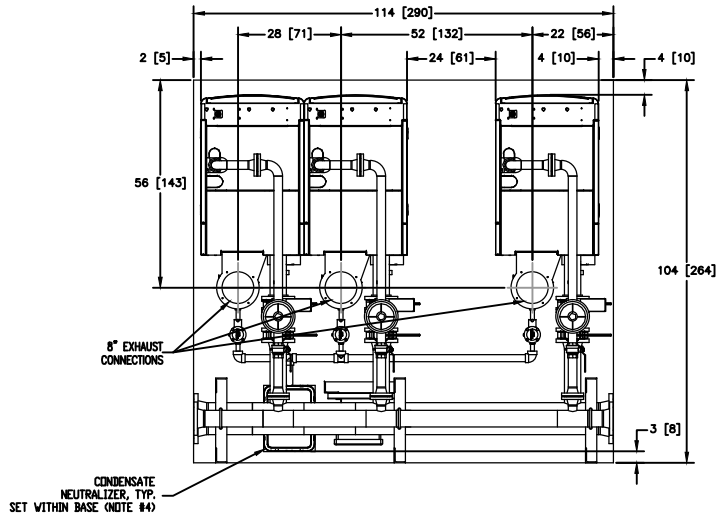

NOTES:

- 1) ALL DIMENSIONS SHOWN ARE IN INCHES [CENTIMETERS].
- 2) AERCO RESERVES THE RIGHT TO MODIFY BOILER DIMENSIONS WITHOUT PRIOR NOTICE.
- 3) INSTALL HW SUPPLY TEMPERATURE SENSOR WITHIN 2-10 FT. OF NEAREST BOILER.
- 4) RELIEF VALVE & NEUTRALIZER KIT PIPED TO DRAIN BY CONTRACTOR.
- 5) PIPING DIMENSIONS ARE APPROXIMATE. FINAL DIMENSIONS MAY VARY DUE TO MANUFACTURING TOLERANCES. DO NOT COMPLETE FIELD PIPING UNTIL SYSTEM IS PROPERLY INSTALLED. FABRICATION ACCEPTS NO LIABILITY DUE TO DIMENSION VARIATION.
- 6) DO NOT RIG FROM SYSTEM PIPING.
- 7) LEVEL AND SHIM BASE BEFORE ANCHORING.
- 8) DO NOT BIND SYSTEM CONNECTIONS.
- 9) FIELD PIPING MUST BE SUPPORTED INDEPENDENT OF SYSTEM CONNECTIONS.
- 10) IF APPLICABLE, INTERNAL DRAINS ARE NOT TRAPPED. CONTINUE DRAIN PIPING IN COMPLIANCE WITH LOCAL CODES.
- 11) IF APPLICABLE, BASE MUST BE GROUTED (3000 PSI CONCRETE).
- 12) REFER TO BMK1500/2000 BOILERS DIMENSIONAL DRAWING FOR MORE DETAILS.
- 13) SINGLE POINT ELECTRICAL CONNECTIONS REQUIRED TO LOAD CENTER IN FIELD. ALL ITEMS ON SKID ARE FACTORY WIRED.
- 14) PIPE SIZES MAY VARY PER FIELD REQUIREMENT.
- 15) BENCHMARK PLATINUM SHOWN. SAME DIMENSIONS APPLY TO STANDARD BENCHMARK MODELS.

AERCO 100 ORITANI DRIVE BLAUVELT, NY 10913
aerco.com

BMK 1500 & 2000
SKID PACKAGE SYSTEM - THREE UNITS
DIMENSIONAL DRAWING

DWN. BY S.S. DATE 050615
SCALE NTS
APPD. P.R. DATE 050615

SD-A-1072

REV.
B